

③ 吊 鏢 差金付 (階段構) 3個 (西1・ハ1・ニ1)

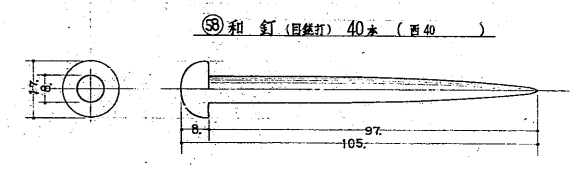

④ 和 釘 (目録打) 40本 (西40)

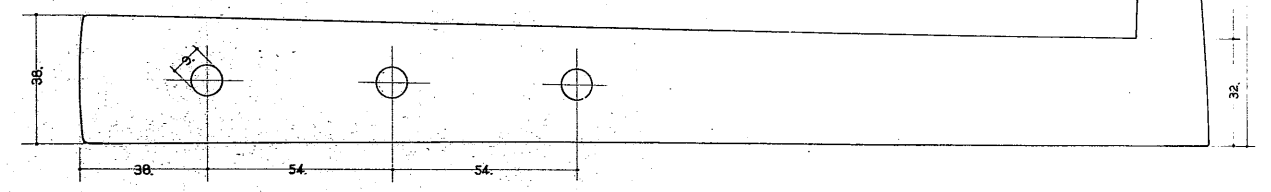

⑤ 大 目 鏢 (柱頭取付用) 13ヶ (西13)

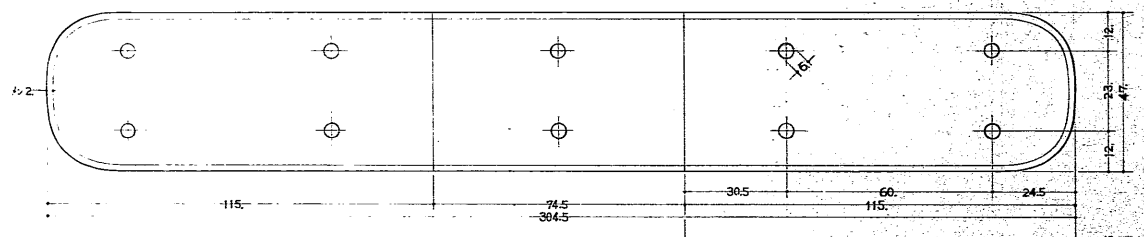

⑥ 飾金物 (階段構) 8ヶ (西4・ハ4)

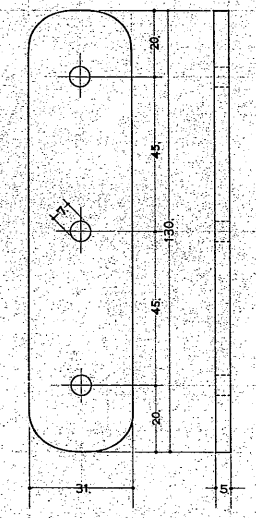
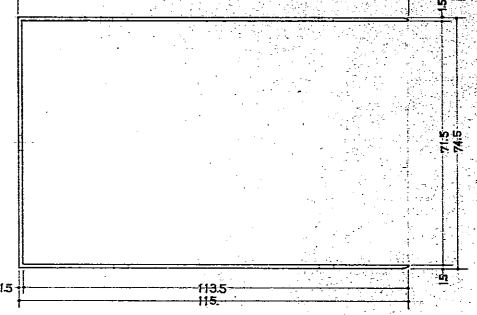

⑦ 飾金物 (階段構) 1ヶ (ハ1)

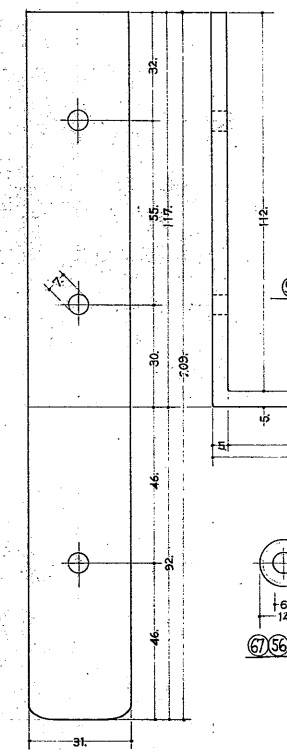

⑧ 飾金物 (階段構) 1ヶ (ハ1)

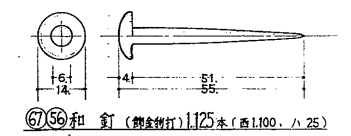

⑨ 和 釘 (御成物打) 1125本 (西1100・ハ25)

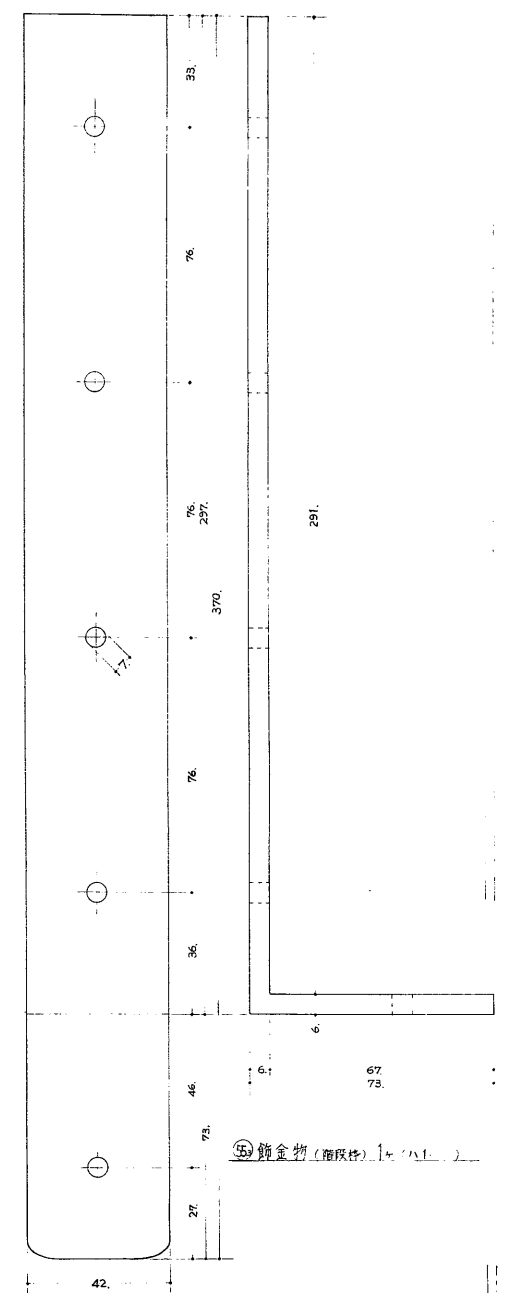

⑩ 飾金物 (階段構) 1ヶ (ハ1)

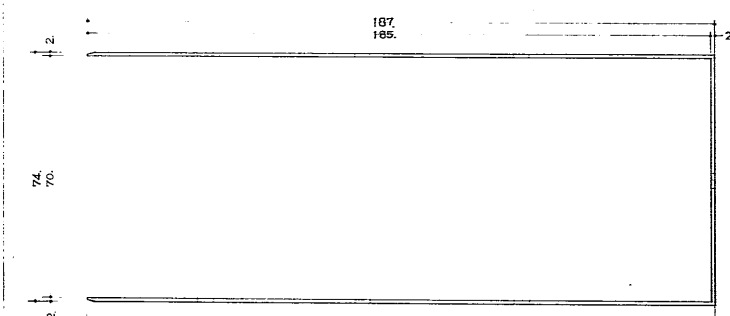

⑪⑫⑬⑭⑮ 和 釘 (裏取付用) 460本 (西25・ハ35・ニ10・東30)

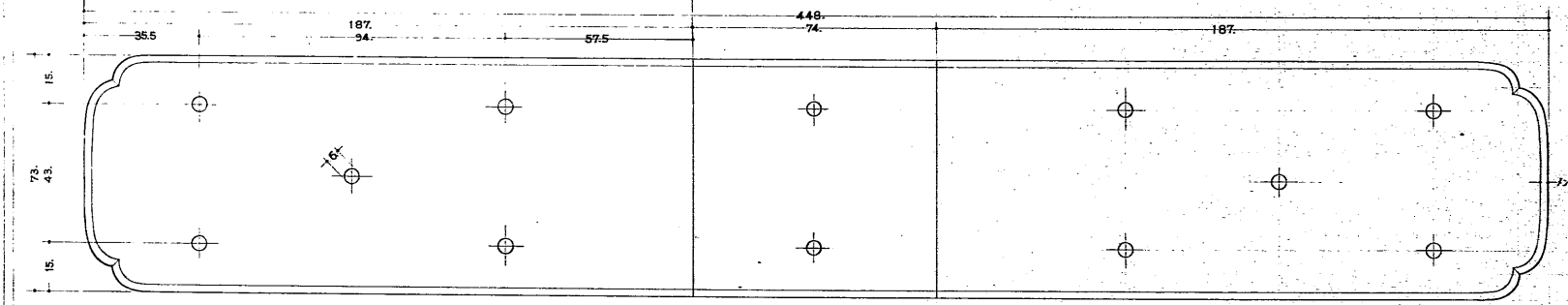
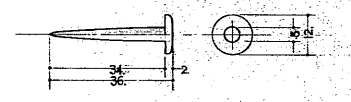

⑯ 飾金物 (階段構) 1ヶ (ハ1)

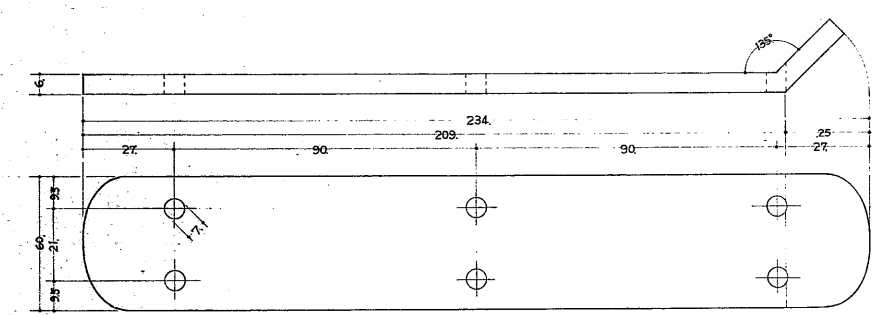

⑰ 飾金物 (階段構) 2ヶ (ハ2)