

# 昭和十八年度第二豫備金支出貯水池工事設計圖

縮尺 1/50

備前及西之丸  
断面圖

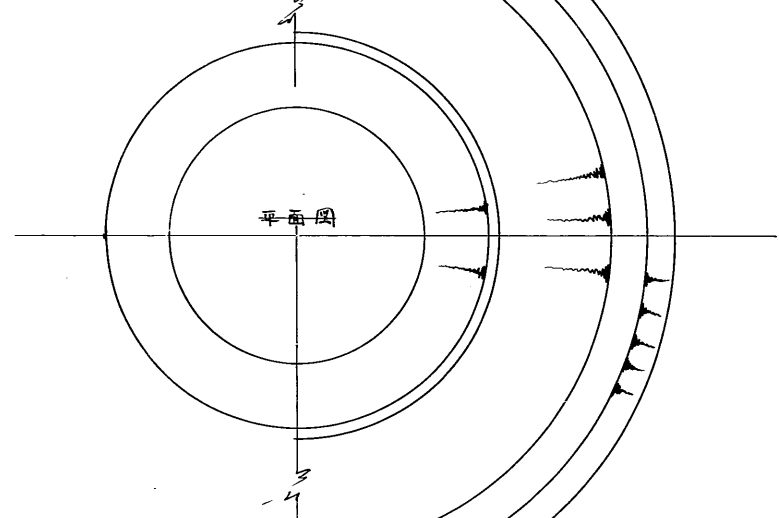
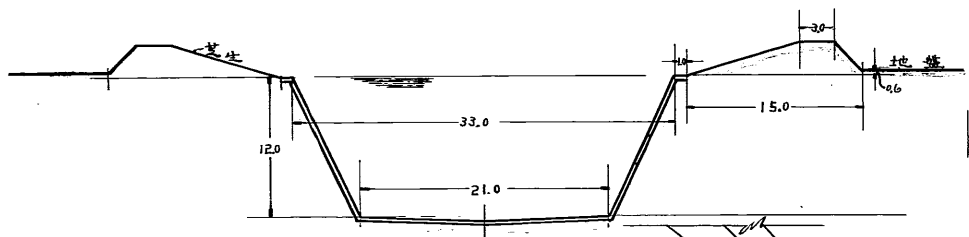

天守閣中庭  
断面圖

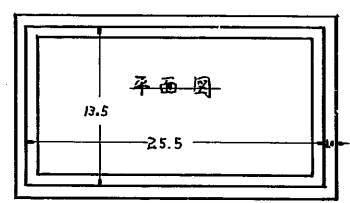
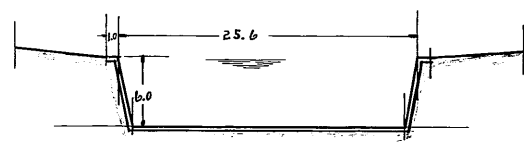

と、一門前  
断面圖

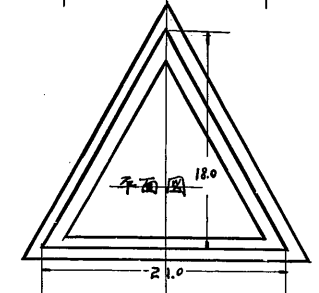
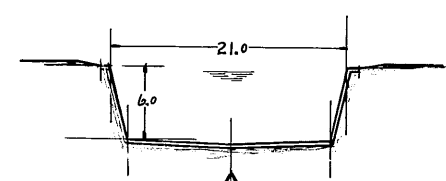

腹切丸

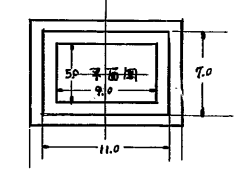
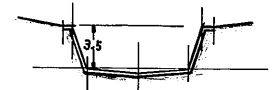

方、櫓東方  
断面圖

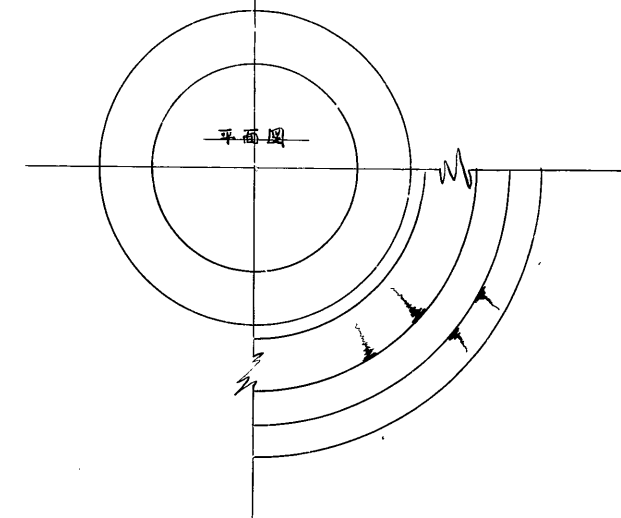
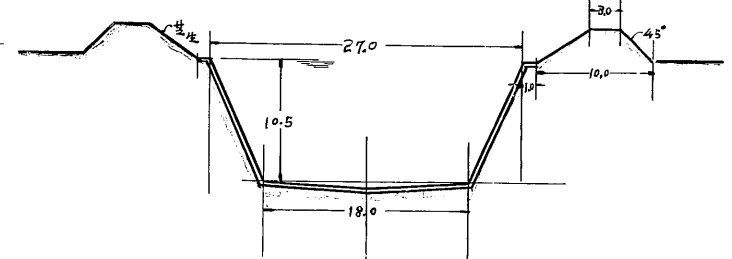

は、門東方  
断面圖

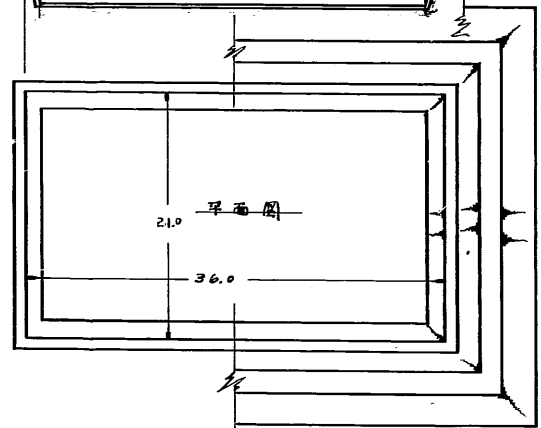
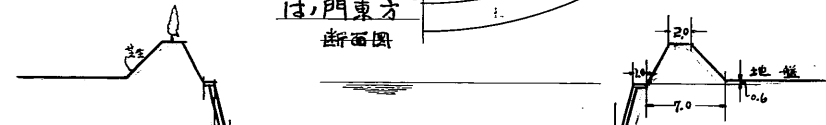

は、櫓前  
断面圖

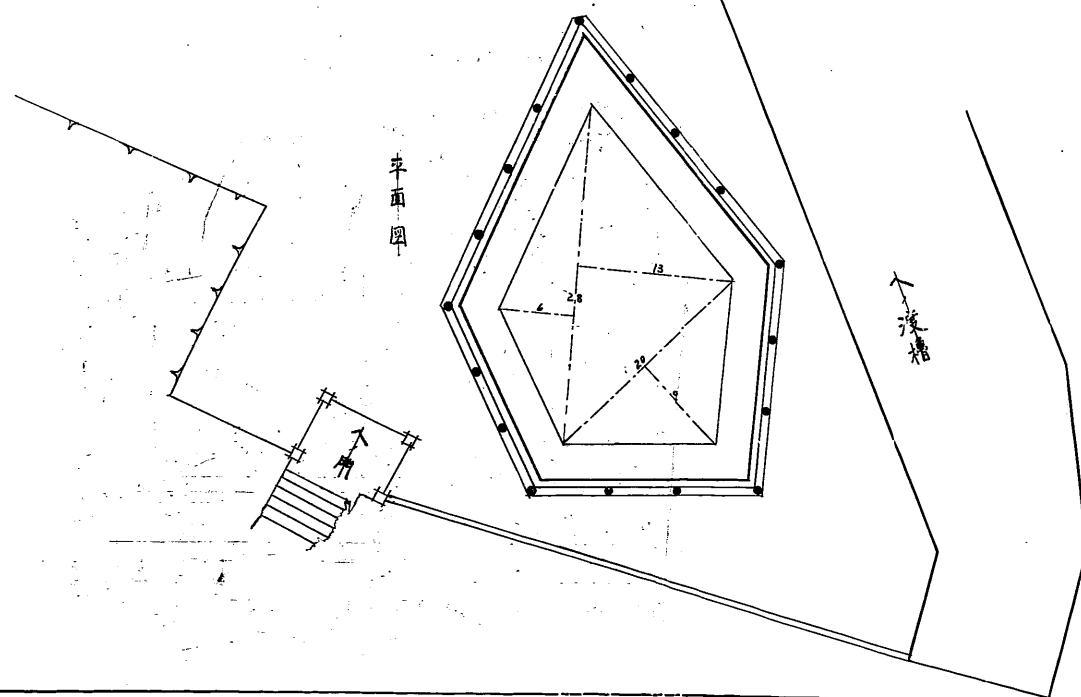
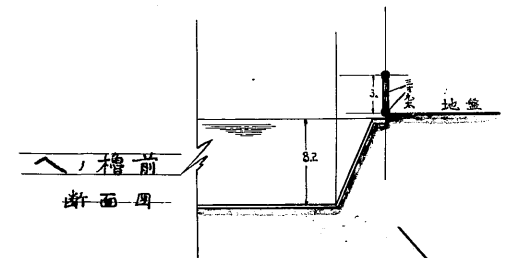

三國塚周囲

